



SECTIONAL GARAGE DOORS

NEW. MatchColor preferred colours matching Hörmann entrance doors

HÖRMANN





4

Good reasons to try
Hörmann sectional
doors.



14

Door styles.
Inspirations.



48

Design.
Equipment.
Accessories.

Responsibility for generations

The Hörmann family business has over 85 years of experience as a construction component specialist. This gives us an obligation to both current and future generations. That's why environmental responsibility plays such an important role for us. With this in mind, we develop innovative solutions for sustainable products and intelligent environmental protection.



“A GOOD REPUTATION MUST BE EARNED.”

August Hörmann

In keeping with the tradition started by the company's founder, the Hörmann brand is a true promise of quality and, with sales of over 20 million doors and operators, is one of Europe's most successful suppliers. Due to the comprehensive international sales and service network, Hörmann is your strong partner for high-quality construction components.

AN EYE ON THE FUTURE. Hörmann is setting a good example. That's why 100% of our electricity needs in Germany come from green electricity. Together with an intelligent and certified energy management system, CO₂-neutral mailing and the recycling of valuable materials, more than 60000 tons of CO₂ are saved each year. In addition, we offset over 100000 tonnes of CO₂ by promoting wind energy and reforestation projects in cooperation with ClimatePartner.



You can find further information at
www.hormann.co.uk/company/environment/



Brand quality made in Germany



The family-owned company Hörmann offers all important construction components for building and renovating projects from a single source. We manufacture in highly specialised factories using state-of-the-art production technologies. Our employees work intensively on new products, continual further developments and improvements to details. The results are patents and unique products on the market.





10-year warranty *

LONG-LASTING. GUARANTEED. All major door and operator components are developed and manufactured by Hörmann. Endurance tests under real conditions ensure mature series products with Hörmann quality. Thanks to this and uncompromising quality assurance, you receive a 10-year warranty on all Hörmann sectional doors and a 5-year warranty on Hörmann operators*

* The complete warranty conditions can be found at: www.hormann.co.uk



Tested and certified

CERTIFIED SAFETY FOR YOU AND YOUR FAMILY.

Hörmann sectional doors are tested and certified in accordance with the high safety requirements of European standard 13241, not only on their own but also in combination with Hörmann operators. It would be hard to find a safer sectional door. And this provides you and your family with safety during daily use.



Space-saving opening and secure closing

Sectional garage doors open vertically upwards and are suspended under the ceiling to save space. This construction principle means you can make full use of the space inside and in front of the garage. Sectional garage doors can be fitted in any garage opening and offer extra passage width. Treat yourself to this comfort and convenience.





CERTIFIED RC 2 SECURITY FEATURES.

In addition to the standard anti-lift kit, which automatically locks your door securely and protects it against being forced open, the sectional garage door LPU 67 Thermo and optionally the LPU 42, wicket doors and side doors come with certified RC 2 security features as standard.

→ Further information can be found starting on page 71.



Watch the video on YouTube or at www.hormann.co.uk/videos



MORE PASSAGE WIDTH. Sectional doors with a passage width extended by up to 14 cm also make it much easier to park modern, larger cars and SUVs (centre figure). With older up-and-over doors, driving in and out is often a matter of millimetres (bottom figure).



Intelligent operating comfort

Control your garage door and entrance gate operators, door operators, entrance door locks, lights and other devices simply, safely and conveniently via hand transmitter, radio switch or smartphone. All operators, receivers and control elements with BiSecur radio technology are 100% compatible with each other.





Only from Hörmann

CERTIFIED SECURITY. The bidirectional BiSecur radio system with particularly secure encryption protocol and stable, interference-free range makes sure that no one can copy your radio signal. This is also confirmed by the security experts of Bochum University and independent test institutes.



Watch the video on YouTube or at www.hormann.co.uk/videos

INTELLIGENT TECHNOLOGY. Hörmann operators impress with more convenience, smart functions and intelligent technology. The standard automatic safety cut-out stops the door securely and reliably if it encounters an obstacle. Your door opens and closes quietly and smoothly with the soft start and soft stop. Our elegant hand transmitters allow you e.g. to open your door from your car. Or you can simply use your smartphone as a door opener with the Hörmann BlueSecur app or the Hörmann Smart Home control centre homee.

→ Further information can be found starting on page 76.

Thanks to the standard automatic safety cut-out, children can play in your yard without worrying.



With the homee Smart Home system, you can control all door functions via your tablet or smartphone.



Choose the door that suits your home

No matter the architectural style, with Hörmann, you are guaranteed to find a sectional garage door style to fit your personal style and home – from straight-lined ribbing to classic panelling in many surface finishes, colours and decors, as well as solid timber doors. Be inspired by the Hörmann variety on the following pages or configure your desired door conveniently on the internet.





THE DOOR OF YOUR CHOICE IN JUST A FEW CLICKS.

With the door configurator, you can conveniently try out many design and product variations at home on your own PC or tablet in advance. You can put your dream door together in just a few clicks by selecting the door type, surface finish, colour and size and also see the recommended retail price of your configuration. If you then upload a picture of your house and place the door in your garage opening, you can see in advance how well your new garage door will match your home.



The Hörmann configurator can be found at:
[www.hormann.co.uk/home-owners-and-renovators/
configurator](http://www.hormann.co.uk/home-owners-and-renovators/configurator)



GERMANY'S BEST-SELLING GARAGE DOOR. More than 5 million customers are convinced of the convenience, safety and design of Hörmann sectional garage doors.



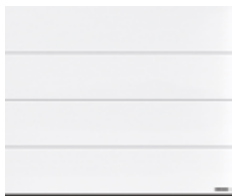

16 L-ribbed



24 M-ribbed



32 S-ribbed

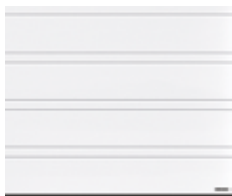

34 D-ribbed



38 S-panelled



40 Solid timber doors

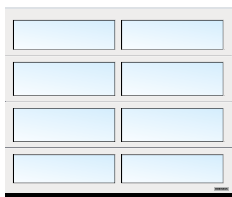

42 Glazed doors



44 Facade / large doors



46 Hinged garage doors







PLANAR SURFACE FINISH. The elegant surface finish in 6 exclusive Matt deluxe Hörmann colours meets all expectations of a modern door design. It impresses by combining a smooth surface finish with fine elegance and matt trendy colours.

→ Available as L-ribbed. All colours and details can be found starting on page 62.





L-ribbed

PAGE 16 / 17. Planar, CH 703 Matt deluxe Anthracite metallic

LEFT. Planar, CH 7016 Matt deluxe Anthracite grey, 3000 mm door height

BOTTOM LEFT. Detail Planar, CH 9006 Matt deluxe White aluminium

BOTTOM RIGHT. Planar CH 9006 Matt deluxe White aluminium. Aluminium entrance door ThermoCarbon style 860 in White aluminium RAL 9006





DURAGRAIN SURFACE FINISH. With this smooth door surface finish, you can choose from 25 detailed, natural and true-colour decors or, if you wish, have your door printed with an individual image. The final coating of high-strength protective paint is especially robust, scratch-resistant and stain-resistant. As a result, your door maintains its attractive look.

→ Available as L-ribbed. All decors and details can be found starting on page 64.



Further information can be found in the "Duragrain surface finish" brochure.





L-RIBBED

TOP LEFT. Duragrain Concrete with matching side door

TOP CENTRE. Duragrain customised style

TOP RIGHT. Duragrain Rusty Steel

BOTTOM. Duragrain Moca





INTELLIGENT ACCESSORIES. You no longer have to go out in any wind and weather to check if your door is closed. At the press of a button, the colour of the LED on the hand transmitter HS 5 BS or the internal push button FIT 5 BS indicates the door position. If required, another push of a button* closes the door. It is the most convenient and secure way to control your door.

→ The accessories are available for all sectional garage doors.

* An additional photocell is required for operation without visual contact to the door.



Further information can be found in the door operators and Smart Home systems brochure.



TOP. L-ribbed, Silkgrain Anthracite grey RAL 7016. Aluminium entrance door ThermoSafe style 504 in Anthracite grey RAL 7016

RIGHT. M-ribbed Silkgrain, Traffic white RAL 9016

LIGHT SOLUTIONS. An LED light strip puts your door and side door in the right light. Hörmann posts offer you more light and security in your yard entrance.



M-ribbed



TOP LEFT. Woodgrain, Window grey
RAL 7040

TOP RIGHT. Woodgrain, Slate grey
RAL 7015

BOTTOM LEFT. Woodgrain, Traffic white
RAL 9016

BOTTOM RIGHT. Detail view of Woodgrain,
Traffic white RAL 9016





WOODGRAIN SURFACE FINISH. On this inexpensive and robust surface with an authentic sawn timber look, minor scratches can be easily repaired.

→ Available as L-, M- and S-ribbed as well as S-panelled. All colours and details can be found starting on page 59.

SLATEGRAIN SURFACE FINISH. Slate slabs are the model for this textured surface finish that gives your door a special look.

→ Available as L- and M-ribbed. All colours and details can be found starting on page 59.





M-RIBBED

TOP LEFT. Detail view of Slategrain Traffic white RAL 9016

BOTTOM LEFT. Slategrain, Anthracite grey RAL 7016

TOP RIGHT. Slategrain, Traffic white RAL 9016

BOTTOM RIGHT. Slategrain, Anthracite grey RAL 7016





DECOGRAIN SURFACE FINISH. The detailed surface finish is available in five natural-looking timber decors and an anthracite-coloured decor with metallic effect. Your door remains beautiful for a long time thanks to the special surface protection with UV-resistant plastic film coating on the outside of the steel sections.

→ Available as L- and M-ribbed.
All decors and details can be found starting on page 63.





M-RIBBED

TOP LEFT. Detail view of Decograin Golden Oak

TOP CENTRE. Decograin Golden Oak

TOP RIGHT. Decograin Dark Oak

BOTTOM. Decograin Titan Metallic CH 703





TOP. L-ribbed, Silkgrain, Basalt grey RAL 7012 with matching side door

BOTTOM LEFT. Single-leaf multi-purpose door MZ Thermo65, Traffic white RAL 9016

BOTTOM RIGHT. M-ribbed, Woodgrain, Anthracite grey RAL 7016 with wicket door





SIDE DOORS. The door as a second entrance to your garage is available in the same surface finishes, colours and decors as your garage door – if desired, also with exactly the same alignment of the ribbing. This ensures that everything fits together. If you value good thermal insulation and also want to reduce the risk of condensation forming on the inside, a multi-purpose door MZ Thermo with thermal break is the best choice for you.

→ Further information can be found starting on page 72.

WICKET DOORS. A wicket door in the garage door lets you quickly and easily access gardening tools, bicycles or wheelbarrows in your garage. The wicket door features a stainless steel threshold rail that is merely 10 mm high in the centre and 5 mm high at the sides. This reduces the risk of tripping and makes it easier to wheel things through.

→ Further information can be found starting on page 74.





MATCHCOLOR. NEW. With the coordinated colours for sectional garage doors, entrance doors, side doors and sheet steel doors, you can design your home in perfect colour harmony.

→ Available for the Woodgrain, Slategrain and Silkgrain surface finishes. All colours and details can be found starting on page 60.

S-ribbed



LEFT. Woodgrain, Fir green RAL 6009

BOTTOM. Woodgrain, Anthracite grey RAL 7016 with matching side door and aluminium entrance door ThermoSafe style 501



D-ribbed



SILKGRAIN SURFACE FINISH. Thanks to its elegant door appearance, this silky smooth surface finish is the first choice for modern architecture. A 50% thicker exterior sheet on the sections also ensures higher stability and even smoother running.

→ Available as L-, M- and D-ribbed. All colours and details can be found starting on page 59.

LEFT. Silkgrain, Window grey RAL 7040

RIGHT. Silkgrain, Anthracite grey RAL 7016,
aluminium entrance door ThermoSafe
style 860 in Anthracite grey RAL 7016

BOTTOM. Detail view of Silkgrain,
Window grey RAL 7040



INLAY DESIGN ELEMENTS. Give your door a very personal touch. The inlays in stainless steel or timber look as well as individually in RAL as desired are inserted into the ribbing of the sectional doors entirely according to your wishes (right figure).

→ Available for M- and D-ribbed. All designs and details can be found starting on page 55.

DESIGN ELEMENTS. Give your door a very special style. Choose one of our design styles or arrange and combine the brushed stainless steel design elements according to your wishes. House numbers or e.g. street names are possible as well.

→ Available for L- and D-ribbed. All designs and details can be found starting on page 54.





TOP. D-ribbed, Silkgrain, Anthracite grey RAL 7016 style 500 with inlay in timber look

BOTTOM LEFT. L-ribbed, Silkgrain, Anthracite grey RAL 7016 with design element "House number"

BOTTOM RIGHT. L-ribbed, design style 461, Silkgrain, Quartz grey RAL 7039 with glazing elements; Hörmann aluminium entrance door ThermoSafe style 173, Quartz grey RAL 7039



LIGHT ELEMENTS. Classic or Sunrise glazings are a perfect match for panelled doors and give your door a special look. But glazings are not only a design element, they also provide daylight in the garage.

→ Available for all door styles.
All glazings and details can be found starting on page 57.



S-panelled



TOP LEFT. Woodgrain, Traffic white RAL 9016

TOP CENTRE. Woodgrain, Terra brown RAL 8028

TOP RIGHT. Woodgrain, Slate grey RAL 7015

BOTTOM. Woodgrain, Moss green RAL 6005
with classic glazing S2 in sandwich version



Solid timber doors

NATURALLY BEAUTIFUL. These doors made of untreated or brushed Nordic pine are excellently suited for timber houses or buildings with many timber elements, such as e.g. timber framing or facade elements. Choose from among six elegant door styles.

→ Further information can be found starting on page 66.





LEFT. Door style 401, solid timber Nordic pine, painted larch

TOP RIGHT. Door style 405, painted white on site with hinged door fitting kits and decorative handles

BOTTOM RIGHT. M-ribbed, solid timber Nordic pine, untreated

Glazed doors

ALUMINIUM FRAME DOOR ART 42 / ART 42 THERMO.

This door version with standard profile or profile with thermal break impresses with more light in the garage or with better ventilation in the parking boxes of collective garages if grille infills are used.

→ Further information can be found starting on page 56.





TOP. ALR F42 Vitraplan, brown tinted

LEFT. ART 42 Thermo with synthetic double pane, frame in Anthracite grey
RAL 7016, aluminium entrance door ThermoSafe style 650, Anthracite grey
RAL 7016, optional side elements



INDUSTRIAL SECTIONAL DOOR ALR F42 VITRAPLAN.

The door has an especially clear and elegant touch thanks to surface-mounted, flush-fitting glazing. The frame profile is concealed, so nothing detracts from the overall appearance.



More detailed information can be found in the "Industrial sectional doors" brochure.



Facade / large doors

INDUSTRIAL SECTIONAL DOOR ALR F42 FOR ON-SITE CLADDING FLUSH WITH THE FACADE.

Design your sectional door according to your wishes with timber, metal, ceramics, plastic and many other materials. The door basis for facade cladding is a Hörmann industrial sectional door ALR F42 with an aluminium frame construction and PU sandwich infill.

INDUSTRIAL SECTIONAL DOOR SPU F42 PLUS. This door version is the ideal solution for garages up to 7000 mm wide and for special fitting situations where an operator cannot be fitted above the door.



Further information can be found in our Architect's Programme at www.hormann.co.uk/architects-service/architects-programme/ or seek the expert advice of your Hörmann specialised dealer.



TOP. SPU F42 Plus M-ribbed, Silkgrain, Anthracite grey RAL 7016

LEFT. ALR F42 with on-site, flush-fitting cladding



Hinged garage doors

EASY ACCESS. With the double-leaf hinged garage doors, you can either open both leaves or even just one leaf, e.g. in order to take a bicycle out of the garage. Enjoy maximum comfort by equipping your hinged garage door with an operator. The thermally insulated sections provide good insulation and are available in all surface finishes.

→ Further information can be found starting on page 75.

CUSTOMISED LEAF DIVISION. Design your hinged garage door entirely to suit your needs. The door leaves are available in both symmetrical and asymmetrical division. The symmetrical division, with door leaves of equal width, offers a harmonious door appearance. In the asymmetrical division*, the traffic leaf comes in a width of 870 mm, which allows easy pedestrian passage into the garage. The width of the fixed leaf results from the total width of the door. You can also choose to position the traffic leaf on the left or right side of the door.

* Up to 2000 mm door width

LEFT. M-ribbed, Woodgrain, Traffic white RAL 9016

BOTTOM. S-ribbed, Woodgrain, Light grey RAL 7035







50

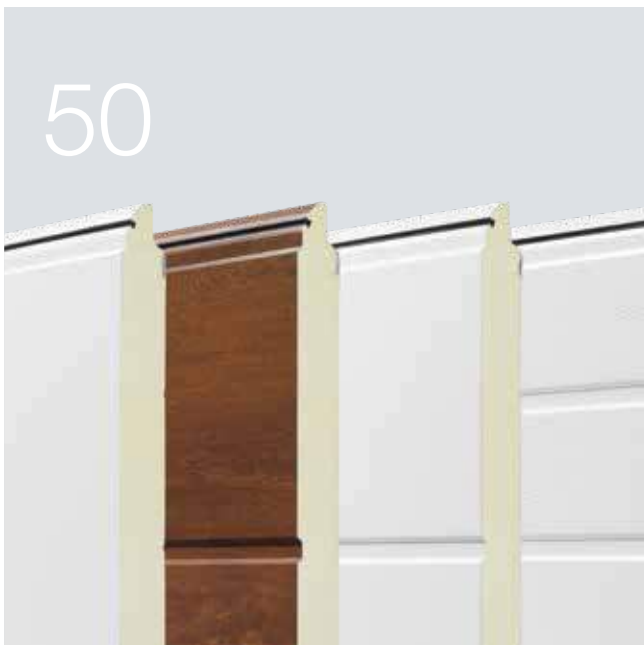

60



76



Design. Equipment. Accessories.

- 50 Steel sectional doors
- 56 Aluminium frame doors
- 57 Glazing
- 58 Surface finishes, colours, decors
- 66 Solid timber sectional doors
- 68 Equipment
- 72 Side doors
- 74 Wicket doors
- 75 Hinged garage doors
- 76 Operators
- 78 Accessories
- 80 Modernisation solutions
- 84 Dimensions and fitting data

Steel sectional doors

Door leaf versions



LPU 67 Thermo

- Energy-saving door with excellent thermal insulation
- 67-mm-thick sections with thermal break
- RC 2 security features as standard

LPU 42

- Good insulation and door travel properties
- Double-skinned 42-mm-thick sections
- Optional RC 2 security features

LTE 42

- Inexpensive solution for free-standing garages
- Single-skinned sections
- No thermal insulation

Surfaces

Woodgrain, Slategrain and Silkgrain in Traffic white RAL 9016, 10 MatchColor preferred colours and 5 Color preferred colours



Sandgrain in 2 colours



Planar in 6 colours



Decograin in 6 decors



Duragrain in 25 decors



| | LPU 67 Thermo | LPU 42 | LTE 42 |
|---|--|---|--|
| Performance characteristics according to European standard 13241 | | | |
| Section material | Galvanised sheet steel with polyester-primer coating | Galvanised sheet steel with polyester-primer coating | Galvanised sheet steel with polyester-primer coating |
| Section thickness | Double-skinned, 67 mm | Double-skinned, 42 mm | Single-skinned |
| Thermal insulation U-value fitted door | 1.0 W/(m ² ·K) ¹⁾ | 1.4 W/(m ² ·K) ¹⁾ | 6.5 W/(m ² ·K) ¹⁾ |
| Acoustic insulation | Approx. 25 dB | Approx. 25 dB | Approx. 20 dB |
| Wind load ⁵⁾ | Class 3 | Class 3 | Class 2 |
| Air / water tightness | Class 3 ⁴⁾ / Class 3 ³⁾ | Class 3 ⁴⁾ / Class 3 ³⁾ | Class 0 ²⁾ / Class 0 ²⁾ |
| Max. width Max. height | 5000 mm 3000 mm | 6000 mm 3000 mm | 5000 mm 3000 mm |
| Styles / surface finishes | | | |
| S-ribbed | | Woodgrain | Woodgrain, (Traffic white RAL 9016) |
| M-ribbed | Silkgrain, Decograin (3 decors) | Woodgrain, Slategrain, Silkgrain, Sandgrain, Decograin | |
| L-ribbed | Silkgrain, Decograin (3 decors) | Woodgrain, Slategrain, Silkgrain, Sandgrain, Planar, Decograin, Duragrain | |
| D-ribbed | | Silkgrain | |
| S-panelled | | Woodgrain | Woodgrain, (Traffic white RAL 9016) |

¹⁾ The U-values apply to fitted doors without glazing with the dimensions 5000 × 2250 mm

²⁾ Doors with ventilation slots, classes 2 – 3 on request

³⁾ Up to 70 Pa water pressure

⁴⁾ Available for panelling and L-ribbing (LPU 42 doors with S-, M-, or D-ribbing as well as with wicket door: class 2)

⁵⁾ Higher wind load classes on request

Steel sectional doors

Door leaf construction



Only from Hörmann

Uniform spacings at every door height

1 Section transition

The door leaf of a sectional door consists of several sections that are flexibly connected with a tongue-and-groove system. With Hörmann, the transitions are shaped so that they are practically invisible when the door is closed. See for yourself!

2 Ribbing

A ribbing is stamped into the exterior sheet of the section. It has the same appearance as a section transition.

3 Uniform spacings

For a particularly harmonious door appearance, Hörmann divides the ribbing and the section transitions evenly at every door height.

4 High-quality primer coating

The sections are optimally protected by the double-sided hot-galvanised sheet steel in conjunction with the high-quality polyester primer coating in Grey white RAL 9002 on the inside.

5 Permanently beautiful door appearance

On the outside, depending on the surface, the high-quality polyester primer coating, the UV-resistant plastic film coating or the final coating with high-strength protective paint gives your door a permanently beautiful appearance.

Standard styles



S-ribbed (LPU 42, LTE 42), Traffic white RAL 9016



D-ribbed (LPU 42), Traffic white RAL 9016



M-ribbed (LPU 67 Thermo, LPU 42, LTE 42), Traffic white RAL 9016



S-panelled (LPU 42, LTE 42), Traffic white RAL 9016



L-ribbed (LPU 67 Thermo, LPU 42), Traffic white RAL 9016

Steel sectional doors

Design elements for LPU 42 and LPU 67 Thermo

Styles with design elements



L-ribbed (LPU 67 Thermo, LPU 42), Traffic white RAL 9016, design element style 450, matching side door

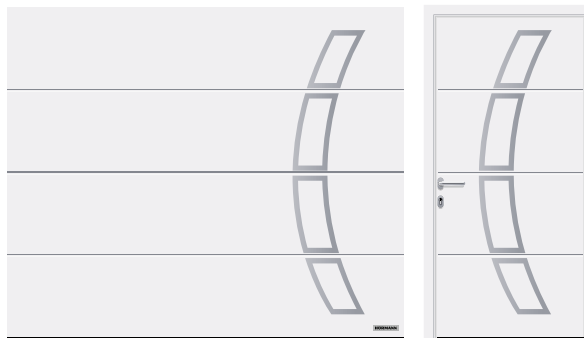

L-ribbed (LPU 67 Thermo, LPU 42), Traffic white RAL 9016, design element style 457, matching side door

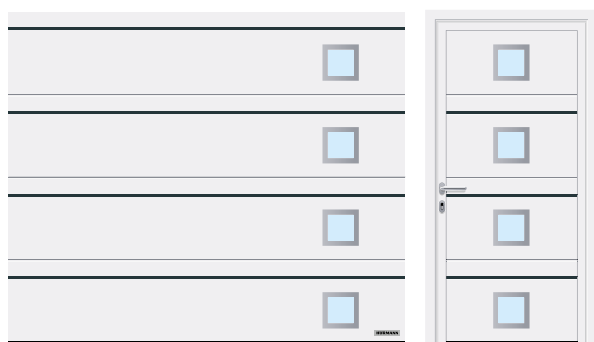

D-ribbed (LPU 42), Traffic white RAL 9016, inlay style 501 design element and style 461 design element Anthracite grey RAL 7016, matching side door

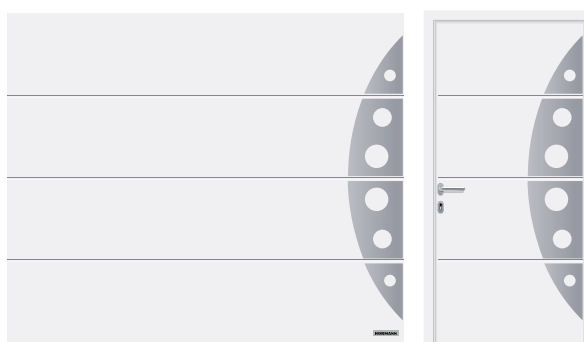

L-ribbed (LPU 67 Thermo, LPU 42), Traffic white RAL 9016, design element style 458, matching side door

Design elements

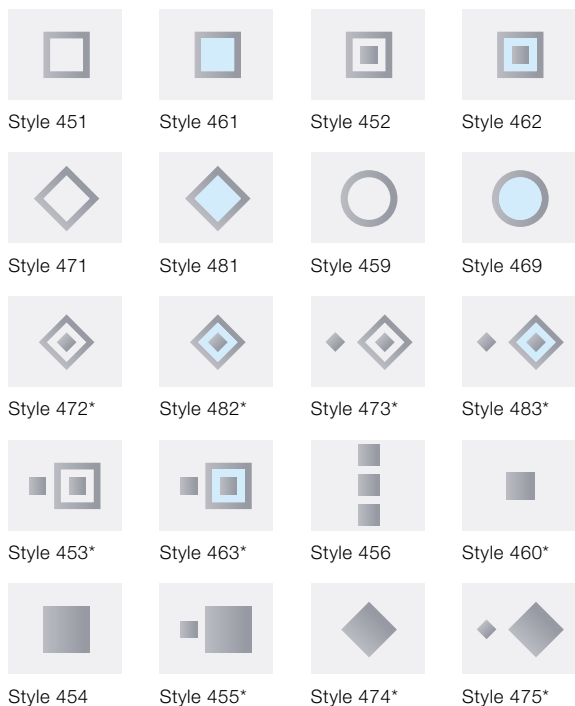

* Only LPU 42

Glazing



Design element in brushed stainless steel with optional real glass* for styles 461 and 481

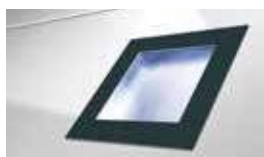

Design element in Anthracite grey RAL 7016 painted with plastic glazing for styles 461, 462, 463, 469, 481, 482 and 483

Styles with inlay design elements



D-ribbed (LPU 42), Traffic white RAL 9016, inlay style 500 design element with divided inlays in timber look



D-ribbed (LPU 42), Traffic white RAL 9016, inlay style 502 design element in Steel blue RAL 5011



M-ribbed (LPU 42), Traffic white RAL 9016, inlay style 503 design element in stainless steel look



M-ribbed (LPU 42), Traffic white RAL 9016, inlay style 504 design element in timber look, in the wicket door

Inlay design elements



Stainless steel look



Timber look



RAL as desired (shown in RAL 9005)

Design elements "Numbers and words"

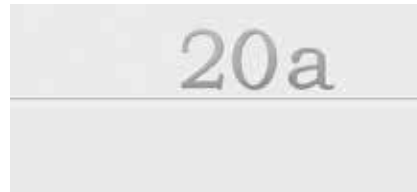

Positive view, modern font



Negative view, classic font

Aluminium frame doors

ART 42 / ART 42 Thermo

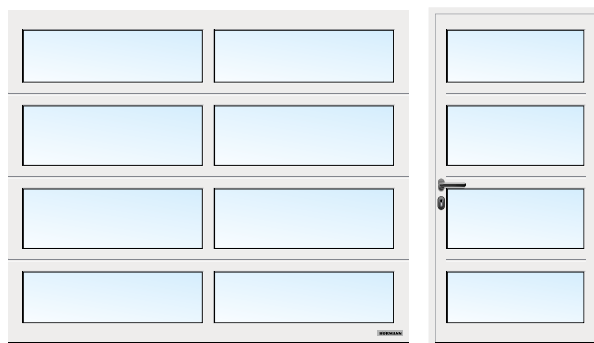

ART 42 glazed, Traffic white RAL 9016

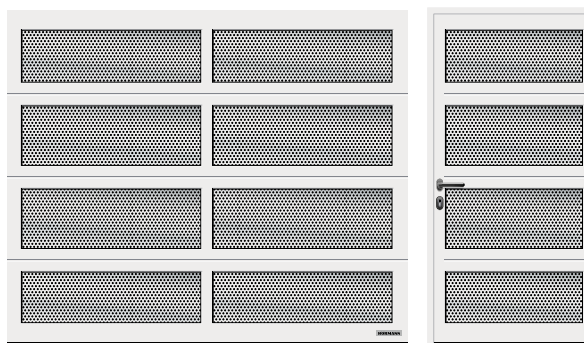

ART 42 with perforated sheet, Traffic white RAL 9016

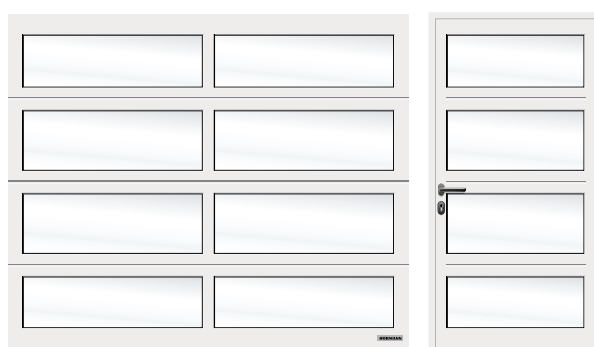

ART 42 glazed white tinted, Traffic white RAL 9016

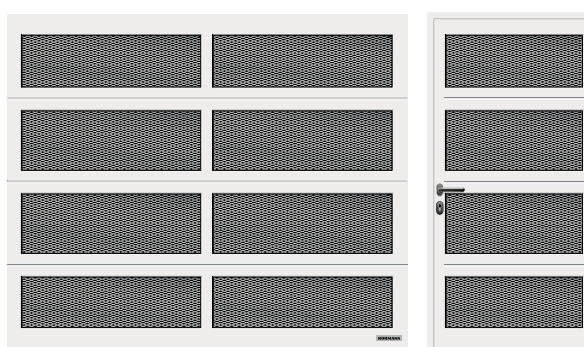

ART 42 with expanded mesh, Traffic white RAL 9016

Section view



ART 42

ART 42 Thermo

ART 42 / ART 42 Thermo

| | |
|---|---|
| Frame material | Aluminium |
| Frame thickness | 42 mm |
| Thermal insulation ART 42 U-value fitted door | 4.0 W/(m ² ·K) ¹⁾ |
| Thermal insulation ART 42 Thermo U-value fitted door | 3.4 W/(m ² ·K) ¹⁾ |
| Acoustic insulation | R = approx. 20 dB |
| Wind load ³⁾ | Class 3 |
| Air / water tightness | Class 2 ²⁾ / Class 3 ²⁾ |
| Max. width | 5500 mm |
| Max. height | 3000 mm |

¹⁾ The U-values apply to fitted doors with synthetic double pane S2 with the dimensions 5000 × 2250 mm

²⁾ Doors with ventilation slots, classes 2 – 3 on request

³⁾ Higher wind load classes on request

Glazing variants



1



2



3



4



5



6



7

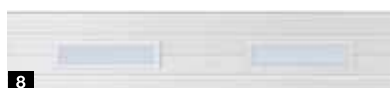

8



9

Glazing variants for LPU 42 and LPU 67 Thermo

- 1 Classic glazing S0¹⁾
- 2 Classic glazing M0¹⁾
- 3 Classic glazing L0¹⁾
- 4 Classic glazing S1
- 5 Classic glazing S2
- 6 Sunrise glazing S10³⁾
- 7 Sunrise glazing S60⁴⁾ (left door half shown)
- 8 Glazing type D¹⁾
- 9 Aluminium light strips²⁾

Infill variants for LPU 42, LPU 67 Thermo, ART 42 and ART 42 Thermo

- 10 Polycarbonate double pane, clear
Synthetic double pane, clear
- 11 Synthetic double pane, white tinted
(opal / clear)
- 12 Synthetic double pane, crystal structure
- 13 Multiple-moulded pane
- 14 Synthetic double pane, brown tinted
- 15 Synthetic double pane, grey tinted
- 16 PU sandwich infill, smooth
- 17 PU sandwich infill, Stucco
- 18 Perforated stainless steel sheet
- 19 Stainless steel expanded mesh
- 20 Crimped mesh
- 21 Welded grille

Glazings (1 to 8, 10) correspond to a door width of 2500 mm

¹⁾ Individual arrangement of glazings is possible

²⁾ Rails are possible

³⁾ Door width 2130 – 2750 mm

⁴⁾ Door width 4751 – 5500 mm

Infill variants



10



11



12



13



14



15



16



17



18



19



20



21

Clear plastic glazing from Hörmann comes with DURATEC glazing as standard.

It offers you decisive advantages:

- A permanently clear view
- Improved thermal insulation

Only from Hörmann



Duratec
Extremely scratch-resistant

Matching appearance

With door leaf and frame

Only from Hörmann

Door leaf, fascia panel and side frames matching in Woodgrain Traffic white RAL 9016

MATCHING APPEARANCE OF FRAMES AND DOOR LEAVES.

The harmonious appearance of a door is the result of many small details: The fascia panel **1** is always provided matching the door sections with the surfaces Woodgrain, Sandgrain, Silkgrain, Planar and Decograin. This ensures that everything fits together. The side frames **2** are available with a white Woodgrain surface finish as standard. With frame coverings **3**, the side frames can be easily adapted to the surface finish of the sections.

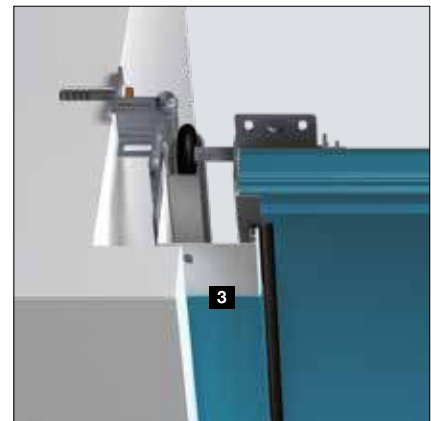
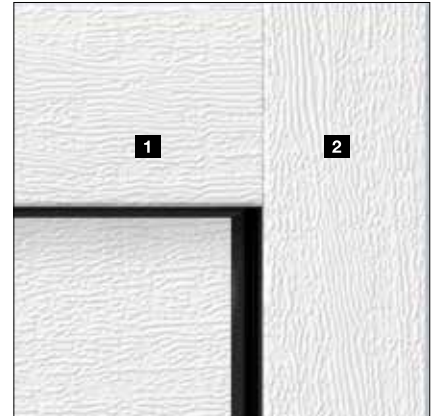

| | Woodgrain | Slategrain | Silkgrain | Sandgrain | Planar | Decograin | Duragrain |
|-------------------------|-----------|------------|-----------|-----------|--------|-----------|-----------|
| Fascia panel 1 | ● | ○ | ● | ● | ● | ● | □ |
| Side frame 2 | ● | ■ | ■ | ■ | ■ | ■ | ■ |
| Frame covering 3 | ● | ● | ● | ● | ● | ● | □ |

- = Same surface finish, colour or decor as the door section
- = Woodgrain surface finish in Traffic white RAL 9016 (with the premium version in Grey white RAL 9002)
- = Smooth surface finish in same colour as the door section
- = Smooth surface finish in a colour matching the door section or in RAL as desired

Woodgrain

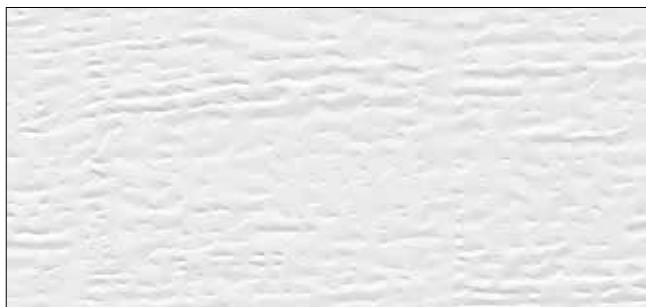

Slategrain

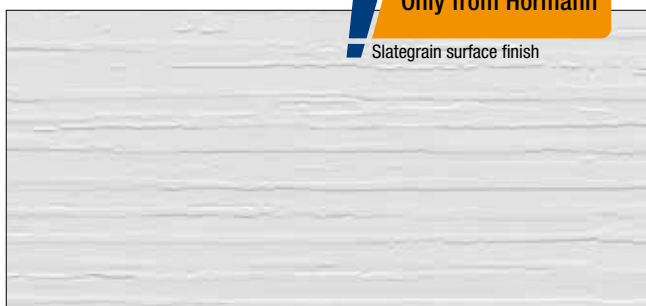

Silkgrain

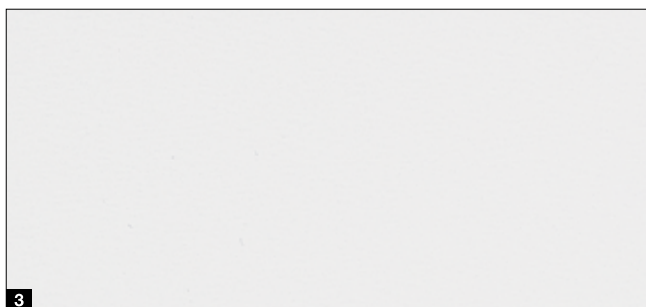

1 Woodgrain, Traffic white RAL 9016

2 Slategrain, Traffic white RAL 9016

3 Silkgrain, Traffic white RAL 9016

Protective coatings for a long, beautiful door appearance

Final coating. The surface finish of the sections is especially robust, scratch-resistant and stain-resistant thanks to the protective paint.

Final coating "Anti-Graffiti". Due to the protective paint on the surface of the section as well as on glazings, design elements, etc., graffiti can be removed with a commercially available special cleaner.

→ Available for the Woodgrain, Slategrain and Silkgrain surface finishes.



1 Double-skinned section

2 Galvanisation

3 Polyester-primer coating

4 Final coating or "Anti-Graffiti" final coating

Preferred colours

For the Woodgrain, Slategrain, Silkgrain surface finishes



MatchColor .NEW

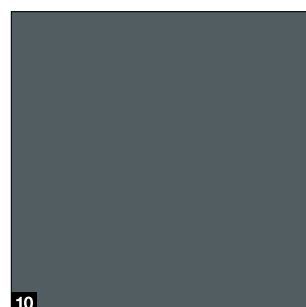
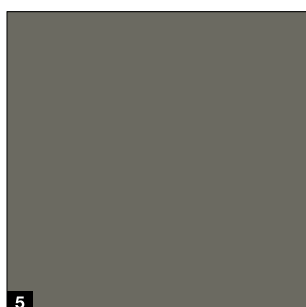
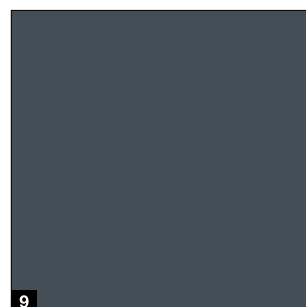
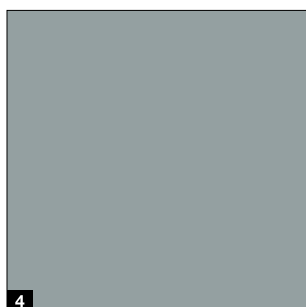
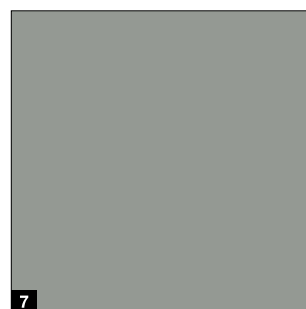
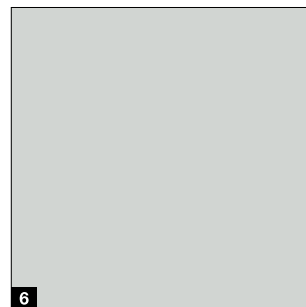
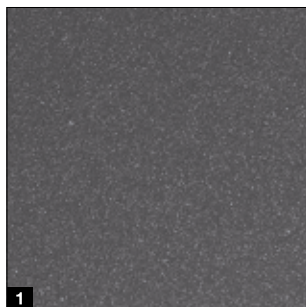

MatchColor:

MatchColor .NEW

Design your home in perfect colour harmony – with the MatchColor preferred colours for sectional garage doors, entrance doors, side doors and sheet steel doors with a matching appearance. Enjoy the harmonious overall appearance thanks to matching colours. That is Hörmann brand quality!

Tipp

The smooth Silkgrain surface finish harmonises particularly well with the entrance door surface finishes.

Please note:

In connection with an optional final coating or "Anti-Graffiti" final coating, you receive all MatchColor preferred colours as a Color preferred colour in which a matching appearance of sectional garage doors, entrance doors, side doors and sheet steel doors is not guaranteed.

Color

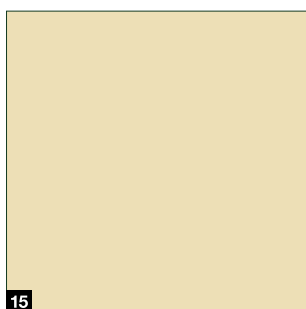
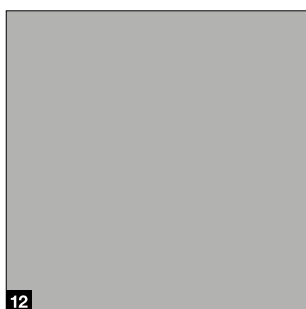
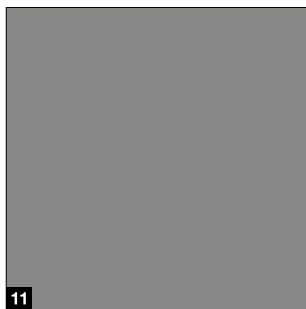

MatchColor .NEW

- 1 CH 703 Anthracite metallic
- 2 RAL 9005 Jet black
- 3 RAL 8028 Terra brown
- 4 RAL 7040 Window grey
- 5 RAL 7039 Quartz grey
- 6 RAL 7035 Light grey
- 7 RAL 7030 Stone grey
- 8 RAL 7016 Anthracite grey
- 9 RAL 7015 Slate grey
- 10 RAL 7012 Basalt grey

Color

- 11 RAL 9007 Grey aluminium
- 12 RAL 9006 White aluminium
- 13 RAL 6009 Fir green
- 14 RAL 6005 Moss green
- 15 RAL 1015 Light ivory

RAL as desired

The Woodgrain, Slategrain and Silkgrain surface finishes are optionally available in around 200 RAL Classic colours (with the exception of pearl-effect and fluorescent colours) as well as in many NCS and DB colours.

Please note:

Sectional garage doors are generally supplied in Grey white RAL 9002 on the inside of the door. Dark colours should not be used for double-skinned steel doors that are exposed to the sun, as possible section deflection may damage the door. All colours based on RAL. The colours and surface finishes shown are subject to the limitations of the printing process and cannot be regarded as binding.

Please consult with your local Hörmann specialised dealer.

Surfaces

Sandgrain, Planar, Decograin

Sandgrain

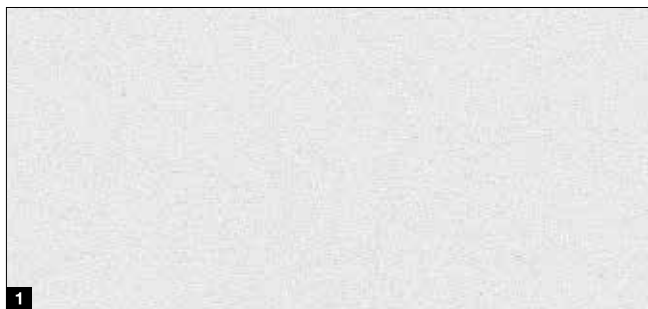

Planar

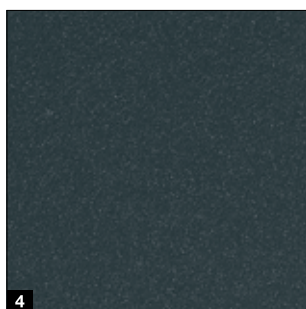
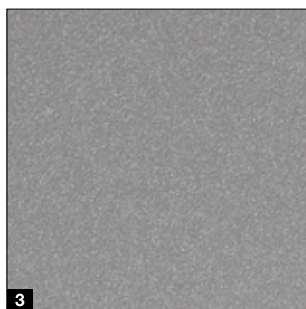
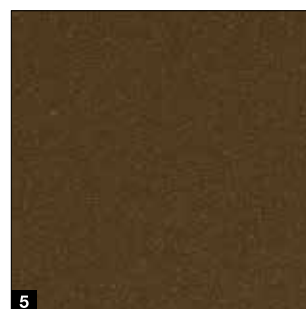
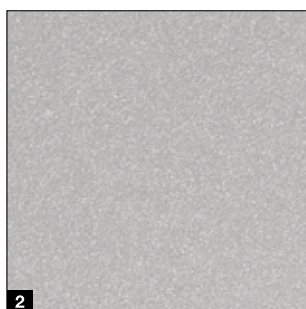
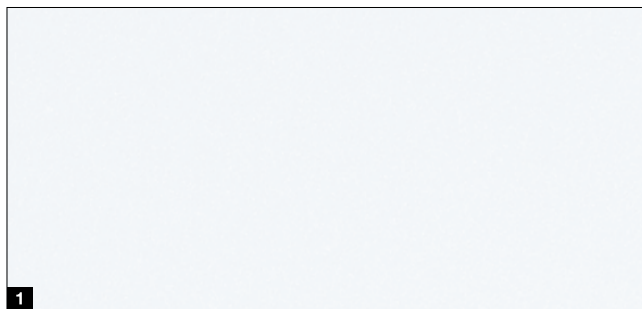

Decograin

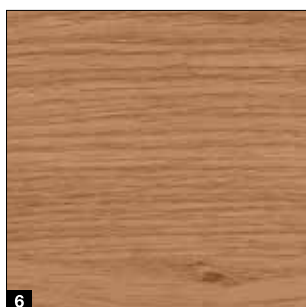
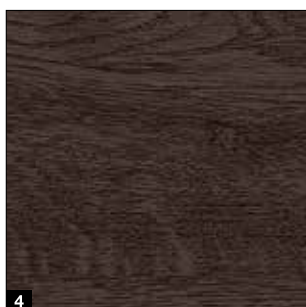
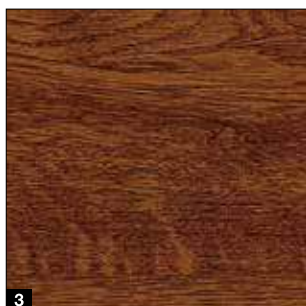

Sandgrain standard colour

- 1 RAL 9016 Traffic white

Sandgrain preferred colour

- 2 RAL 7016 Anthracite grey

Planar standard colour

- 1 CH 9016 Matt deluxe Traffic white

Planar preferred colours

- 2 CH 9006 Matt deluxe White aluminium.
- 3 CH 9007 Matt deluxe Grey aluminium
- 4 CH 7016 Matt deluxe Anthracite grey
- 5 CH 8028 Matt deluxe Terra brown
- 6 CH 703 Matt deluxe Anthracite metallic

Decograin decors

- 1 Titan Metallic CH 703: Anthracite with a metallic effect
- 2 Golden Oak: medium brown, golden yellow oak decor
- 3 Dark Oak: walnut-coloured oak decor
- 4 Night Oak: dark, intense oak decor*
- 5 Rosewood: mahogany-coloured timber decor*
- 6 Winchester Oak: natural-coloured knotty oak decor*

* Not for LPU 67 Thermo

Please note:

Sectional garage doors are generally supplied in the colour Grey white, RAL 9002, on the inside of the door.

Dark colours should not be used for double-skinned steel doors that are exposed to the sun, as possible section deflection may damage the door. All colours based on RAL. The colours and surface finishes shown are subject to the limitations of the printing process and cannot be regarded as binding.

Please consult with your local Hörmann specialised dealer.

Surface finish

Duragrain



Duragrain
Extremely scratch-resistant

Scratch-resistant and stain-resistant

The innovative digital printing process in combination with the final coating of high-strength protective paint is only available from Hörmann. This is the basis for a permanently beautiful door appearance. For Duragrain doors, we optionally supply the frame covering and the panels in a colour that matches the decor.



- 1 Double-skinned section
- 2 Galvanisation
- 3 Priming
- 4 Innovative digital print
- 5 Final coating with high-strength protective paint

Duragrain

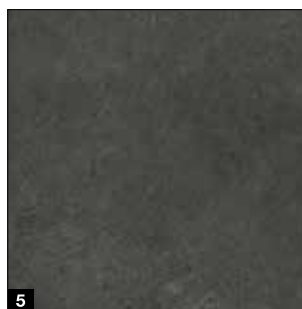
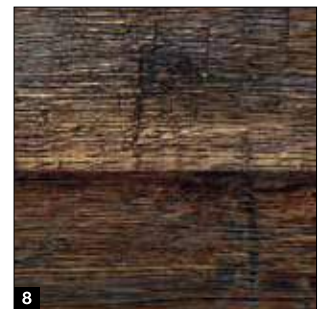
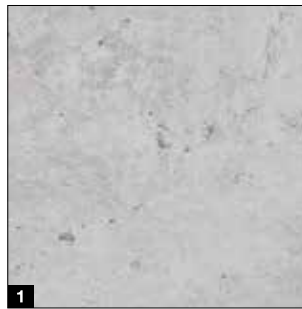

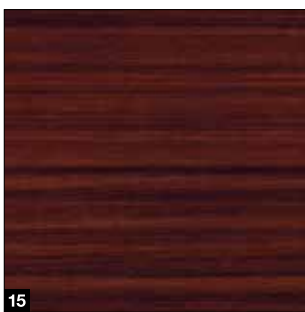
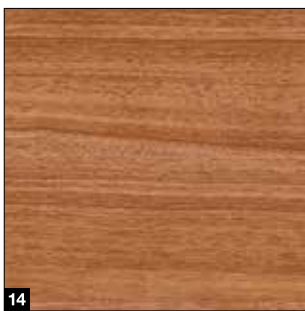
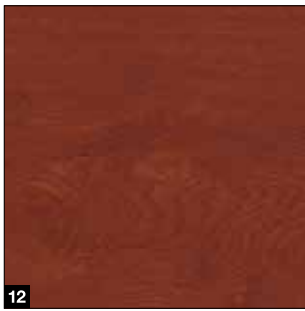
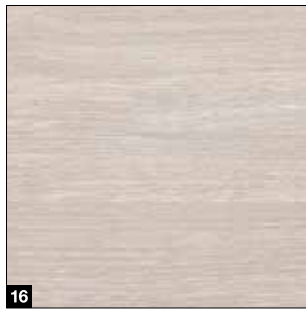

Duragrains decors

- 1 Concrete
- 2 Beige
- 3 Moca
- 4 Grigio
- 5 Grigio scuro
- 6 Rusty Steel
- 7 Bambus
- 8 Burned Oak
- 9 Cherry
- 10 Nature Oak
- 11 Fichte
- 12 Rusty Oak
- 13 Noce sorrento balsamico
- 14 Noce sorrento natur
- 15 Sapeli
- 16 Sheffield
- 17 Teak
- 18 Used Look
- 19 Terra Walnut
- 20 Walnuss Kolonial
- 21 White brushed
- 22 White Oak
- 23 Whiteoiled Oak
- 24 Whitewashed Oak
- 25 Malt Oak .NEW

Individual styles

Design your Duragrains door with your personal favourite style. For this, simply upload a photo at www.hormann.co.uk, configurator or contact your Hörmann specialised dealer.



Solid timber sectional doors

LTH 42 .NEW

Standard styles



S-ribbed



M-ribbed



L-ribbed



Panel

LTH 42 .NEW

| | |
|---|---------------------------|
| Section material | Solid timber |
| Section thickness | 42 mm |
| Thermal insulation U-value ¹⁾ | 2.9 W/(m ² ·K) |
| Wind load class ³⁾ | 3 |
| Air / water tightness class ²⁾ | 0 / 0 |
| Max. width | 5000 mm |
| Max. height | 3000 mm |

¹⁾ The U-values apply to fitted doors without glazing with the dimensions 5000 × 2250 mm

²⁾ Doors with ventilation slots, classes 2 – 3 on request

³⁾ Higher wind load classes on request

Design styles



Style 401



Style 402

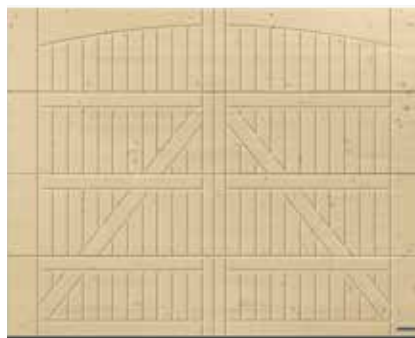

Style 405



Style 405, with optional hinged door fitting kit "Exclusive"

Types of timber



Types of timber

- 1 Nordic Pine, untreated
- 2 Nordic Pine, brushed

Wood preservatives

- 3 Pine
- 4 Larch
- 5 Nut
- 6 Sand beige
- 7 Silver

Coatings

- 8 RAL 9016 Traffic white
- 9 RAL 9001 Cream
- 10 RAL 7035 Light grey

Wood preservatives

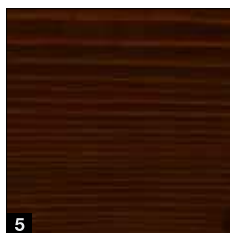
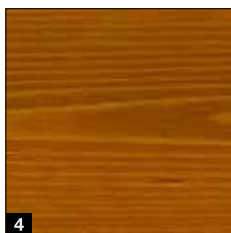

Coatings

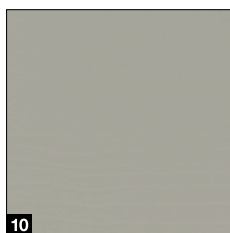
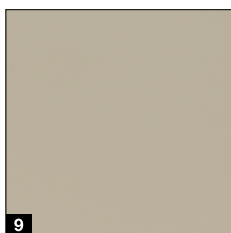
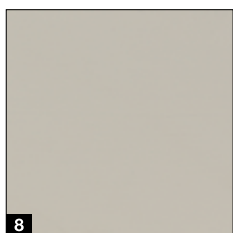

Please note:

Timber is a natural product. Durability depends on many factors such as: Type of weathering, constructive wood protection, mechanical load and the choice of colour. Timely maintenance work is required to achieve durability, therefore annual maintenance is recommended. Do not use dark glazes in direct sunlight. Keep the garage well ventilated.

All colours based on RAL. The colours and surface finishes shown are subject to the limitations of the printing process and cannot be regarded as binding.

Please consult with your local Hörmann specialised dealer.

Standard equipment

For a secure and long-lasting door function



Tension spring technology with multi-spring system ¹

up to 4000 mm door width or 2625 mm door height

The patented system reliably secures the door leaf from falling and prevents a broken spring from flying out and injuring people.

Torsion spring technology with integrated spring safety device ²

from 4000 mm door width or 2625 mm door height as well as for doors with wicket door and for solid timber doors

The patented spring safety device stops the door travel immediately in the event of a spring breaking, thereby preventing the door leaf from falling.

Secure door guide in safety tracks ³

Patented, adjustable rollers, sturdy roller holders and safety tracks ensure that there is no danger of the door "derailing". The door leaf is safely parked under the ceiling.

Finger trap protection ⁴

on the inside, outside and on the hinges

The unique shape of the door sections eliminates trap points, both between the sections and on the hinges.

Trap guard on the side frames ⁵

With Hörmann, the frames are completely closed from top to bottom. There are no gaps between the door leaf and frame in which fingers could get trapped!

Only from Hörmann

European patent

Plastic frame shoe ⁶

A non-brittle, 4 cm plastic frame shoe covers the frame where it is prone to rusting and offers long-term protection against corrosion, even with waterlogging, which is unmatched by competitor solutions. Together with the door's bottom seal, the frame shoe makes for a bottom edge that is visually appealing.



Optional equipment

for more convenience and security

Premium version ¹

For LPU 42, LPU 67 Thermo, ART 42 and ART 42

Thermo: For a beautiful interior view, the door hardware, frames, tracks and the connection rail are painted in Grey white RAL 9002 ¹⁾ matching the section interior. Twin rollers ensure very quiet and gentle door travel.

Ventilation slot on the topmost section ²

For LPU 67 Thermo ²⁾ and LPU 42 ²⁾ with operator SupraMatic or ProMatic (from year of manufacture 2012):

The optional folding roller bracket means that you only open the top section of your door to ventilate the garage. The bottom door section remains sealed on the ground, thus offering protection against small animals or leaves.

Emergency release lock ³

For LPU 42, LTE 42 and LTH 42: To manually unlock your garage from the outside in an emergency, you can use an emergency release lock. An inconspicuous round cylinder (cannot be integrated in the master key system) is connected to the emergency release of the operator boom on the inside.

Door handle for emergency release ⁴

For all door versions: The door handle is equipped with a lock that can be integrated into the master key system. Use the handle to unlock the emergency release of the operator boom via a Bowden cable on the inside of the door. The door handles are available in the following versions: black plastic, white cast aluminium, RAL 9016, brushed stainless steel (see figure), brown cast aluminium, RAL 8028.

ThermoFrame ⁵

For all door versions: The plastic profile can be easily fitted together with the door frame, creating a thermal break between the frame and brickwork, thus improving thermal insulation by up to 15% ³⁾. In addition, extra sealing lips on both sides and in the upper section of the door lower the loss of heating energy from the garage interior.

¹⁾ Galvanized spring assembly incl. holder, spring safety device, cable drum, operator boom

²⁾ Only track application N, L, Z, not possible for doors with wicket door

³⁾ For a double-skinned sectional garage door LPU 42 with the dimensions 5000 x 2250 mm





RC 2 security features

Standard for LPU 67 Thermo, optional for LPU 42:

The certified RC 2 security features makes your door even safer and is recommended by police information centres. Further information can be found at www.k-einbruch.de



Watch the video on YouTube or at www.hormann.co.uk/videos



Side doors

NT 60 / NT 80

Door sizes*

- Width (single-leaf)
990 – 1115 mm
- Width (double-leaf)
1130 – 3000 mm
- Height (single- / double-leaf)
1990 – 2183 mm

Leaf frames

- Narrow version **1**
(profile type 1, only for single-leaf side doors)
- Wide version **2**
(profile type 2)

Standard equipment

- 60-mm-thick weather-resistant aluminium profiles in the colour of the sections **3** or, in the case of Duragrain infills, in a colour matching the decor
- Traffic leaf with black plastic lever handle set with oval rose escutcheons and profile cylinder lock **4**
- 3-way adjustable hinges optionally in black, white or aluminium natural finish **5**
- Fixed bolt for locking the fixed leaf with double-leaf side doors **6**

Optional equipment

- Concealed hinges for an elegant door view in the version with aluminium block frame **7**
- Break-in resistant RC 2 security features with 3-point-locking (latch, bolt, 2 locking hooks) and security rose escutcheon for the version with wide leaf frame (profile type 2) **8**
- Double-leaf side doors with asymmetrical division
- Lever handle or lever / knob handle sets in aluminium natural finish **9**, cast aluminium RAL 9016 **10**, brown cast aluminium **11**, brushed stainless steel **12**

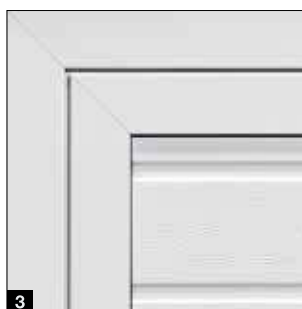

* Depending on leaf frame version



Insulated version NT 80

- Aluminium profile system, frame and threshold rail with thermal break
- 80 mm depth

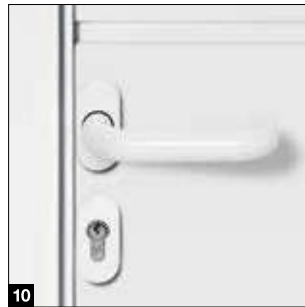

Multi-purpose door MZ Thermo

- Door leaf with thermal break and frame
- Very good thermal insulation value of $1.2 \text{ W}/(\text{m}^2\cdot\text{K})$.
- Optionally in RC 2 version (KSI Thermo)



Further information can be found in the "Steel doors" brochure.

Wicket doors

Without threshold rail

Door versions

- LPU 42 (up to 5 m door width)

Clear opening widths

- Width 830 mm
- Width 1140 mm

Standard equipment

- Aluminium door frame in anodised natural finish **1**
- Sturdy hold-open device prevents the door leaf from sagging and warping **2**
- Concealed hinges for a uniform door view **3**
- Slide rail door closer incl. integrated opening limiter and hold-open device **4**

Optional equipment

- Aluminium door frame in RAL as desired (also different from the door colour) or painted to match the colour of the decor (Planar, Decograin, Duragrain surface finishes)
- Integrated door closer incl. hold-open device for optimum protection and the best appearance **5**
- Multiple-point locking with one bolt and hook bolt per section for a better stability and improved break-in resistance **6**
- Leading photocell VL 2 stops the door without contact and increases safety **7**



Please note:

In some cases, adjacent panelled doors with the same width, with or without a wicket door, may not have a matching panel spacing.

Manually operated garage doors with wicket door do not have an exterior door handle. They are locked from the inside.



Door sizes

- Width 1330 – 3000 mm
- Height 1960 – 2500 mm

Standard equipment

- Door infill made of 42-mm-thick sections **1**
- For S-ribbed, M-ribbed, L-ribbed, D-ribbed and T-ribbed in all colours and decors
- 60-mm-thick aluminium frame profiles in section colour (for Decograin and Duragrain infills in a colour matching the decor) **2**
- 3 sturdy hinges per door leaf (one hinge secured) in aluminium colour **3**
- 3-sided double door seal and double lip seal in the threshold area **4**
- Traffic leaf with aluminium lever handle set and profile cylinder lock **5**
- Fixed leaf with door espagnolette lock **6**

Optional equipment

- Mechanical hold-open device for traffic and fixed leaf for fixing the leaves in an open position **7**
- Mechanical hold-open device with braking and damping function to prevent the leaves from uncontrolled slamming and opening and blocking in any desired position **8**
- Concealed hinges for an elegant door appearance

Operator equipment

- Hinged door fitting kit incl. cover for the ProMatic 4 or SupraMatic 4 operators **9**
- Concealed hinges
- Finger guard or trap guard for an excellent safety inside **10**

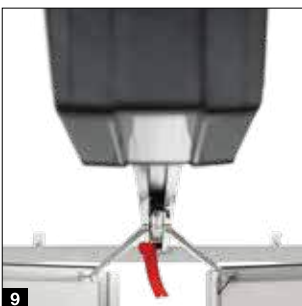

Operators

SupraMatic 4

Supra-fast door opening and smart additional functions

- 75% faster opening speed* up to 25 cm/s
- Smart operation with the BlueSecur app
- Convenient garage ventilation
- Additional opening height
- Up to 3 times (SupraMatic E) or 5 times* (SupraMatic P) brighter LED lighting
- Easy-to-use programming thanks to two 7-segment displays
- High-quality stainless steel operator cover
- Networked with Smart Home systems via the standard HCP interface
- Low power consumption in standby below 1 watt



BiSecur

As standard with two 4-button hand transmitters HSE 4 BS, textured surface black with chrome caps

| Garage door operators | SupraMatic E | SupraMatic P |
|-----------------------|--|--|
| Bluetooth receiver | Integrated, can be switched on and off | Integrated, can be switched on and off |
| HCP bus connection | Integrated | Integrated |
| Cycles per day / hour | 25 / 10 | 50 / 10 |
| Pull and push force | 650 N | 750 N |
| Peak force | 800 N | 1000 N |
| Max. opening speed | 25 cm/s | 25 cm/s |
| Lighting | 20 LEDs | 30 LED chase light |
| Max. door width | 5500 mm | 6000 mm |
| Max. door surface | 13.75 m ² | 15 m ² |

* In comparison with the ProMatic series 3

Only from Hörmann
European patent

Hörmann BlueSecur



Operation by smartphone using the Hörmann BlueSecur app

Premium quality at an attractive price

- 40% faster opening speed* up to 20 cm/s
- Convenient garage ventilation
- Additional opening height
- Up to 2 times* brighter LED lighting
- Networked with Smart Home systems via the standard HCP interface
- Low power consumption in standby below 1 watt



BiSecur

As standard with two 4-button hand transmitters HSE 4 BS, textured surface black with plastic caps

| Garage door operators | ProMatic 4 | ProMatic 4 Akku |
|-----------------------|----------------------|--------------------|
| Bluetooth receiver | Optional (HET-BLE) | Optional (HET-BLE) |
| HCP bus connection | Integrated | Integrated |
| Cycles per day / hour | 25 / 10 | 5 / 2 |
| Pull and push force | 600 N | 500 N |
| Peak force | 750 N | 600 N |
| Max. opening speed | 20 cm/s | 16 cm/s |
| Lighting | 10 LEDs | 10 LEDs |
| Max. door width | 5000 mm | 4000 mm |
| Max. door surface | 11.25 m ² | 9 m ² |

ProMatic 4 Akku

For garages without power connection



Akku with solar module

Accessories

Hand transmitter



HS 5 BS
4 button functions plus query button, high-gloss surface black or white



HS 5 BS
4 button functions plus query button, textured surface matt black



HS 4 BS
4 button functions, textured surface matt black



HS 1 BS
1 button function, textured surface matt black



HSE 1 BS
1 button function, including eyelet for key ring, textured surface matt black



HSE 4 BS
4 button functions, incl. eyelet for key ring, textured surface matt black with chrome or plastic caps



HSE 4 BS
4 button functions, incl. eyelet for key ring, high-gloss surface with chrome caps, colours (shown from left): White, Anthracite grey, Frozen Grey, Classic Grey, Carbon, Silver .NEW



HSD 2-C BS
High-gloss chrome, 2 button functions, can also be used as a key ring



HSZ 1 BS
1 button function, for insertion in vehicle cigarette lighter



Hand transmitter station
In high-gloss surface finish black or white, textured surface finish matt black, for HS 5 BS, HS 4 BS, HS 1 BS



Hand transmitter holder
For wall fitting or fastening to the sun visor of a car, transparent, for HS 5 BS, HS 4 BS, HS 1 BS as well as HSE 1 BS and HSE 4 BS

→ The complete range of accessories can be found in the “Door operators and Smart Home systems” brochure.



Radio code switch FCT 3 BS
3 functions, with illuminated buttons, recessed or surface-mounted fitting possible, plastic housing in Light grey 7040 (also available with 10 functions and hinged cover, painted in White aluminium RAL 9006)



Radio code switch FCT 10 BS
10 functions, with illuminated buttons and hinged cover, recessed or surface-mounted fitting possible, plastic housing in White aluminium RAL 9006



Radio finger-scan FFL 25 BS
2 functions and up to 25 fingerprints, with hinged cover, recessed and surface-mounted fitting possible, plastic housing painted in White aluminium RAL 9006



Radio internal push button FIT 5 BS
4 button functions plus query button, plastic housing in Pure white RAL 9010

Button



Radio internal push button FIT 2-1 BS
2 functions, connection option for max. 2 control elements via cable, e.g. key switch, plastic housing in Pure white RAL 9010



Internal push button IT 1b-1
Large, illuminated button for convenient opening of the door, plastic housing in Pure white RAL 9010



Transponder key switch TTR 1000-1
1 function, 1000 teachable keys, scope of delivery: 1 key and 1 card (more on request), zinc die-cast housing in White aluminium RAL 9006



Code switch CTP 3-1
3 functions, with illuminated lettering and touch-sensitive black surface, zinc die-cast housing in White aluminium RAL 9006



Code switch CTV 3-1
3 functions, particularly robust with metal keypad, zinc die-cast housing in White aluminium RAL 9006 with stainless steel panel



Finger-scan FL 150
2 functions, control via fingerprint, up to 150 fingerprints can be saved, zinc die-cast housing in White aluminium RAL 9006 with stainless steel panel



Key switch 1 STUP 50 2 STAP 50
Recessed version and surface-mounted version, incl. 3 keys, zinc die-cast housing in White aluminium RAL 9006 with stainless steel panel



Internal climatic sensor HKSI 3
For monitoring humidity and automatic ventilation of the garage, plastic housing in Pure white RAL 9010
External sensor HKSA 4
For measuring outdoor humidity, plastic housing in Pure white RAL 9010

Modernisation solutions

For special fitting situations

Standard fitting **1**

Ideally, the available garage has at least 90 mm sideroom. The frame can then be screwed directly into the wall behind the opening. Hörmann sectional doors come with all the necessary fastening materials for this fitting situation.

Frame support set .NEW **2**

The plastic profile is fitted between the frame and brickwork. In the case of damp exterior walls, this prevents the transfer of moisture to the frame and effectively prevents the formation of rust.

Frame coverings

For a harmonious overall appearance, the side frames with frame coverings can be easily adapted to the surface finish of the sections.

3 55-mm-wide frame covering incl. adhesive pads for easy fitting behind the opening, with little sideroom (< 90 mm)

4 90-mm-wide frame covering for fitting in the opening, flush with the wall

Special anchor for frame side fixing

The sectional door frame can be fitted to the side wall of the garage with Hörmann's optional, universally applicable anchors. Irregularities in the wall can be easily compensated, leaving the reveal intact.

3 Fitting with up to 35 mm wall spacing

4 Fitting with angled or irregular side wall

5 Fitting with thermal insulation composite system

6 Fitting with non-load-bearing facades (brick or thermal insulation) with sideroom of 90 to 125 mm and fixing depths of 160 to 240 mm (depending on the anchor version).

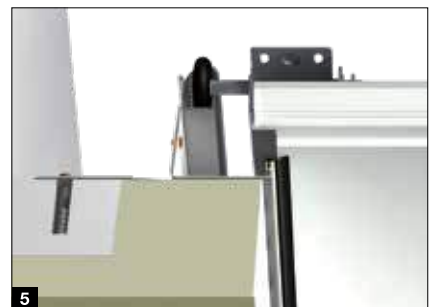

Wind threshold **7**

The profile is simply fitted to the floor and additionally seals off the bottom edge of the door. It prevents the penetration of water across the full door width. The low height ensures barrier-free access.

Compensation set for uneven floors **8**

The adjustable bottom profile compensates the bottom edge of the door leaf up to a height difference of 20 mm. The set for frame compensation consists of 2.5-mm-thick plastic plates, which are positioned to fit perfectly under the frame shoes.

Replacement of up-and-over doors

When removing an old up-and-over door and fitting a new LPU 42 sectional door, a time-consuming process is often necessary to straighten the ground. With our modernisation solutions this work is no longer necessary.

Renovation threshold rail **9**

Replaces the old threshold rail of an up-and-over door for a clean seal with the garage floor.

Low-track door set **10**

The set consists of a compensation profile and special door hardware. The frame must be shortened by 25 mm if the set is used. This can either be ordered in the desired dimensions or shortened on site.

Reno RC set **11**

The rear part of the plastic frame shoe is notched so that it can be fitted on the floor rail of the old up-and-over door. The set consists of a special buffer piece and a specially shaped bottom seal that neatly seals the door in front of the threshold rail.

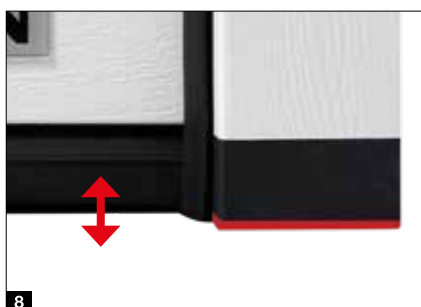

Modernisation solutions

With elegant panels

Fascia panel ¹

Ideally, the available garage has at least 100 mm of clearance in the lintel area (at least 115 mm for doors with operator). The fascia panel for standard fitting behind the opening is supplied with a height of 95 mm as standard. The panel is also available with a height of 125 mm on request.

Double-skinned fascia panel ²

A matching, double-skinned fascia panel for fitting in the opening covers a larger gap between the ceiling and the standard fascia panel. Glazings are also possible after technical clarification. This panel can be optionally supplied as an aluminium light strip.

Flush-fitting fascia panel ³

For LPU 42 doors, a flush-fitting fascia panel is the most elegant solution for an invisible transition between the panel and door leaf. When the door is closed, the top door section is flush-fitting with the panel.

Fascia frame set for lintel and side wall

A door in an inexpensive standard or modernisation size can be fitted in the opening. The remaining gap between the lintel and top door section or side wall and side frame (max. 35 mm) is covered using an optional fascia frame set. This set comes with fascia panels, end caps and fixing materials. The side frame is additionally covered with an optional frame covering:

⁴ 95 mm width for fitting in the reveal

⁵ 125 mm width for fitting in front of the reveal

Retrofit fascia set ⁶

Unattractive gaps and broken masonry in the lintel and reveal area can be covered easily and neatly with the optional retrofit fascia. Additional brickwork and plastering work are no longer required.



| | Woodgrain | Slategrain | Silkgrain | Sandgrain | Planar | Decograin | Duragrain |
|----------------------------|-----------|------------|-----------|-----------|--------|-----------|-----------|
| Frame covering | ● | ○ | ● | ● | ● | ● | □ |
| Fascia panel | ● | ○ | ● | ● | ● | ● | □ |
| Fascia panels | ● | ● | ● | ● | ● | ● | ● |
| Fascia frame set | ● | ○ | ● | ● | ● | ● | □ |
| Flush-fitting fascia panel | ● | ● | ● | ● | ● | ● | ● |
| Retrofit fascia set | ● | ○ | ● | ● | ● | ● | □ |

- = Same surface finish, colour or decor as the door section
- = Smooth surface finish in same colour as the door section
- = Smooth surface finish in a colour matching the door section or in RAL as desired



Dimensions and fitting data

LPU 67 Thermo, LPU 42, LTE 42, ART 42, ART 42 Thermo

Standard and special sizes ¹⁾

| | | | | | | | | | | | | | | | | | | | | | |
|--|------|------|------|------|------|------|------|------|------|------|------|------|------|------|------|------|------|---|---|---|---|
| Grid height (RM) | 3000 | | | | | ● | | | | | | | | | | | | | | | |
| | 2875 | | | | | | | | | | | | | | | | | | | | |
| | 2750 | | | ● | | ● | | | | | | | | | | | | | | | |
| | 2625 | ■ | ■ | ■ | ■ | ■ | | | | | | | | | | | | | | | |
| | 2500 | ■ | ■ | ● | | ● | ● | | | | | | | | | | | | | | |
| | 2375 | ■ | ■ | ● | ● | ● | | | | | | | | | | | | | | | |
| | 2250 | ■ | ● | ● | ● | ● | ● | ● | ● | ● | ● | ● | ● | ● | ● | ● | ● | ● | ● | ● | ● |
| | 2125 | ● | ● | ● | ● | ● | ● | ● | ● | ● | ● | ● | ● | ● | ● | ● | ● | ● | ● | ● | ● |
| | 2080 | ● | ● | ● | ● | ● | ● | ● | ● | ● | ● | ● | ● | ● | ● | ● | ● | ● | ● | ● | ● |
| | 2000 | ● | ● | ● | ● | ● | ● | ● | ● | ● | ● | ● | ● | ● | ● | ● | ● | ● | ● | ● | ● |
| 1875 | ● | ● | ● | ● | ● | ● | ● | ● | ● | ● | ● | ● | ● | ● | ● | ● | ● | ● | ● | ● | |
| Clear frame dimension (LZ) | | | | | | | | | | | | | | | | | | | | | |
| Interior garage dimension (GIM) | | | | | | | | | | | | | | | | | | | | | |
| | 2250 | 2375 | 2500 | 2625 | 2750 | 3000 | 3250 | 3500 | 3750 | 4000 | 4250 | 4500 | 4750 | 5000 | 5250 | 5500 | 6000 | | | | |
| | 2430 | 2555 | 2680 | 2805 | 2930 | 3180 | 3430 | 3680 | 3930 | 4180 | 4430 | 4680 | 4930 | 5180 | 5430 | 5680 | 6180 | | | | |

Modernisation sizes ²⁾

| | | | | | | | | | | | | | | | | | | | | | |
|------------------|------|------|------|------|---|---|--|--|--|--|--|--|--|--|--|--|--|--|--|--|--|
| Grid height (RM) | | | | | | | | | | | | | | | | | | | | | |
| | | | | | | | | | | | | | | | | | | | | | |
| | 2205 | | ● | ● | | | | | | | | | | | | | | | | | |
| | 2080 | ● | ● | ● | ● | ● | | | | | | | | | | | | | | | |
| 1955 | ● | ● | ● | | | | | | | | | | | | | | | | | | |
| LZ | | | | | | | | | | | | | | | | | | | | | |
| GIM | | | | | | | | | | | | | | | | | | | | | |
| | 2190 | 2315 | 2440 | 2940 | | | | | | | | | | | | | | | | | |
| | 2370 | 2495 | 2620 | 3120 | | | | | | | | | | | | | | | | | |

● = Available standard sizes depending on the door type and door style, intermediate sizes available as special sizes
¹⁾ LPU 67 Thermo is only available in special sizes up to 5000 mm door width, SPU F42 Plus up to door sizes 7000 x 5000 mm, ART 42 / ART 42 Thermo up to 5500 x 2250 mm
²⁾ Not available for panel styles with Decograin surface finishes and solid timber doors

■ Track application Z for LPU 42 Silkgrain, LPU 67, ART 42, ART 42 Thermo ■ Track application Z ■ Track application N, L

Ceiling heights and clear passage heights

| | Track application Z | | Track application N | | Track application L | |
|------------------------------|-----------------------|-------------------|-----------------------|------|-----------------------|-------------------|
| | Min. DE ¹⁾ | LDH ²⁾ | Min. DE ¹⁾ | LDH | Min. DE ¹⁾ | LDH ³⁾ |
| With operator | | | | | | |
| Grid height (RM) | | | | | | |
| 3000 | | | 3210 | 3000 | 3115 | 2970 |
| 2875 | | | 3085 | 2875 | 2990 | 2845 |
| 2750 | | | 2960 | 2750 | 2865 | 2720 |
| 2625 | 2740 | 2595 | 2835 | 2625 | 2740 | 2595 |
| 2500 | 2615 | 2470 | 2710 | 2500 | 2615 | 2470 |
| 2375 | 2490 | 2345 | 2585 | 2375 | 2490 | 2345 |
| 2250 | 2365 | 2220 | 2460 | 2250 | 2365 | 2220 |
| 2125 | 2240 | 2095 | 2335 | 2125 | 2240 | 2095 |
| 2000 | 2115 | 1970 | 2210 | 2000 | 2115 | 1970 |
| 1875 | 1990 | 1845 | 2085 | 1875 | 1990 | 1845 |
| With manual operation | | | | | | |
| Grid height (RM) | | | | | | |
| 3000 | | | 3210 | 2950 | 3100 | 2900 |
| 2875 | | | 3085 | 2825 | 2975 | 2775 |
| 2750 | | | 2960 | 2700 | 2850 | 2650 |
| 2625 | 2725 | 2545 | 2835 | 2575 | 2725 | 2525 |
| 2500 | 2600 | 2420 | 2710 | 2450 | 2600 | 2400 |
| 2375 | 2475 | 2295 | 2585 | 2325 | 2475 | 2275 |
| 2250 | 2350 | 2170 | 2460 | 2200 | 2350 | 2150 |
| 2125 | 2225 | 2045 | 2335 | 2075 | 2225 | 2025 |
| 2000 | 2100 | 1920 | 2210 | 1950 | 2100 | 1900 |
| 1875 | 1975 | 1795 | 2085 | 1825 | 1975 | 1775 |

| | Track application Z | |
|------------------------------|-----------------------|------|
| | Min. DE ²⁾ | LDH |
| With operator | | |
| Grid height (RM) | | |
| 2205 | 2320 | 2175 |
| 2080 | 2195 | 2050 |
| 1955 | 2070 | 1925 |
| With manual operation | | |
| Grid height (RM) | | |
| 2205 | 2305 | 2125 |
| 2080 | 2180 | 2000 |
| 1955 | 2055 | 1875 |

¹⁾ With ThermoFrame and operator: see fitting data
²⁾ LPU 67 Thermo: LDH - 55 mm
³⁾ LPU 42: LZ > 3010 mm = LDH - 80 mm; LPU 67 Thermo: LZ < 3000 mm = LDH - 55 mm, LZ > 3010 mm = LDH - 105 mm

Dimensions in mm

Vertical views (with operator)

Track application Z

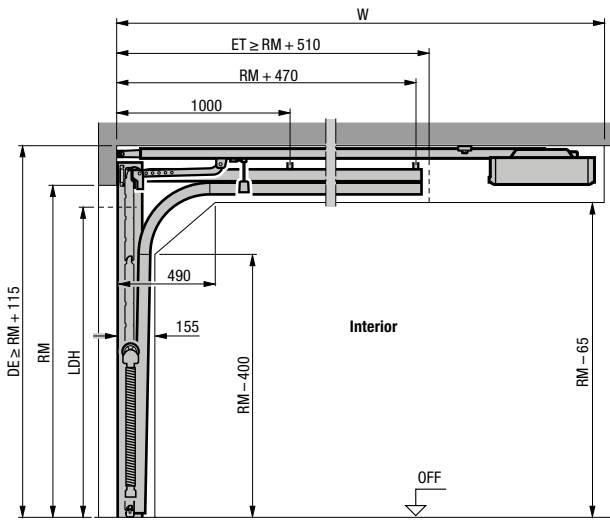

Track application N

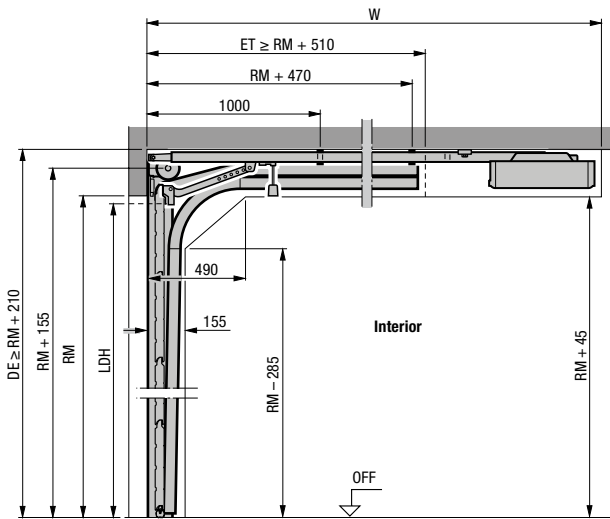

Track application L

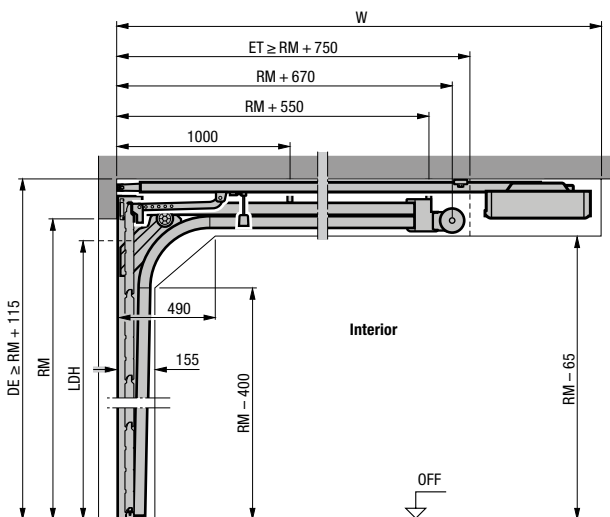

Horizontal view

Track application Z, N, L

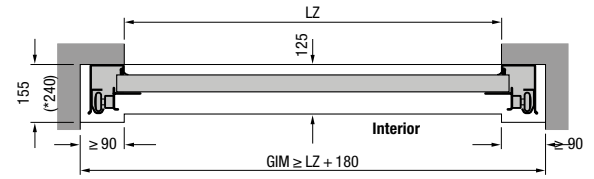

Fitting with track applications Z, N, L

| Overall length operators (W) | Track application Z | Track application N | Track application L |
|------------------------------|---------------------|---------------------|---------------------|
| Doors with operator | | | |
| 2125 (K) | 3200 | 3200 ¹⁾ | 3200 |
| 2250 (K) | | 3200 ²⁾ | |
| 2375 (M) | 3450 | 3450 ¹⁾ | 3450 |
| 2500 (M) | | 3450 ²⁾ | |
| 2625 (L) | 4125 | | |
| 3000 (L) | | 4125 | 4125 |

¹⁾ Max. door height only for LPU 67 Thermo

²⁾ Max. door height only for LPU 42, LTE 42

Explanations

Operator booms

- K Short boom
- M Medium boom
- L Long boom

Ordering sizes

- LZ Clear frame dimension
- RM Grid height
- DE Ceiling height
- W Overall length with operator
- LDH Clear passage height
- GIM Interior garage dimension
- ET Distance back

Note:

The operator should be fitted 40 mm higher for dark coloured doors which are exposed to the sun.

Please note the different dimensions in the fitting data for LPU 42 doors with RC 2 security features, door leaf weight of over 170 kg or door width over 5000 mm as well as for LPU 67 doors.

For track applications such as high-lift door hardware as well as further information, please see the technical manual or contact your Hörmann specialist dealer.

Dimensions and fitting data

Side doors

Horizontal views

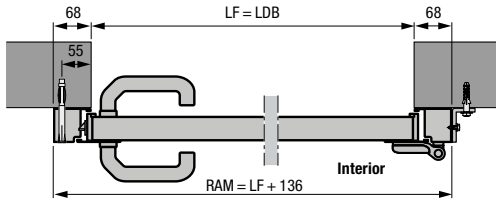

Side door with aluminium block frame, profile type 1
Fitting behind the opening

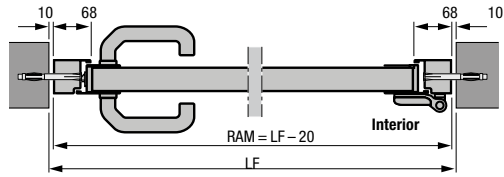

Side door with aluminium block frame, profile type 2
Fitting in the opening

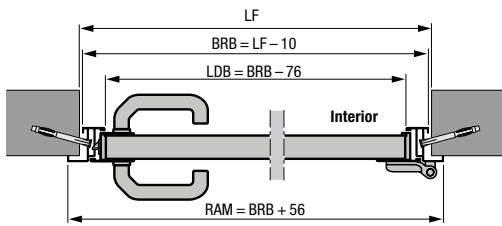

Side door with aluminium corner frame, profile type 1
or 2
Internal fitting

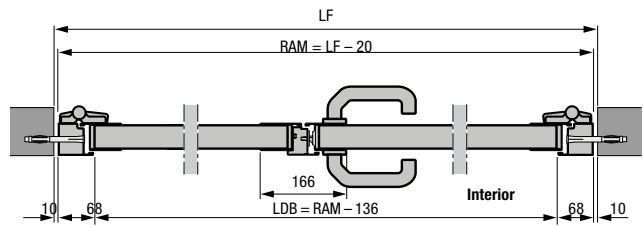

Double-leaf side door with aluminium block frame, profile type 2
Fitting in the opening

- Double-leaf side door with asymmetrical division
- Double-leaf side door opening inwards and outwards

Vertical views

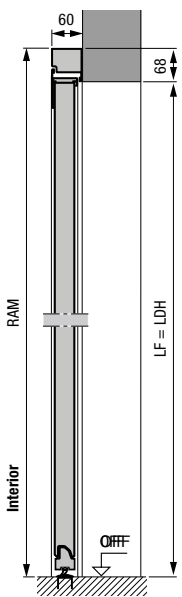

Side door with aluminium block frame, profile type 2
Fitting behind the opening

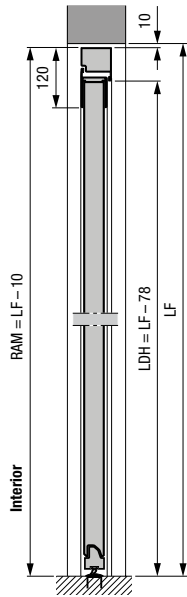

Side door with aluminium block frame, profile type 2
Fitting in the opening

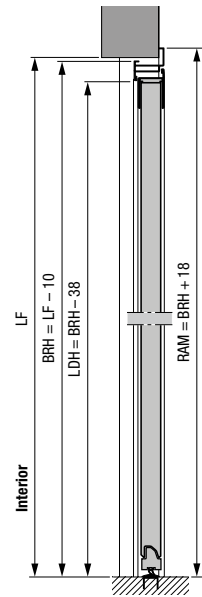

Side door with aluminium corner frame, profile type 2
External fitting

Dimensions in mm

Steel side doors

Profile type 1 (fitting behind the opening) with S-, M-, L-ribbed, S-panelled, block frame

| LF of the opening | Ordering size = RAM | Lever height* from OFF | Door section height B |
|--------------------------|---------------------|------------------------|-----------------------|
| 855 – 875 × 1990 – 2000 | 990 × 2058 | 955 | 500 |
| 855 – 875 × 2115 – 2125 | 990 × 2183 | 1010 | 531 |
| 980 – 1000 × 1990 – 2000 | 1115 × 2058 | 955 | 500 |
| 980 – 1000 × 2115 – 2125 | 1115 × 2183 | 1010 | 531 |

Profile type 2 (fitting behind the opening) S-, M-, L-, D-ribbed, S-panelled, block frame

| LF of the opening | Ordering size = RAM | Lever height* from OFF | Door section height B |
|--------------------------|---------------------|------------------------|-----------------------|
| 855 – 875 × 1990 – 2000 | 990 × 2058 | 1050 | 500 |
| 855 – 875 × 2115 – 2125 | 990 × 2183 | 1050 | 531 |
| 980 – 1000 × 1990 – 2000 | 1115 × 2058 | 1050 | 500 |
| 980 – 1000 × 2115 – 2125 | 1115 × 2183 | 1050 | 531 |

Profile type 2 (fitting in the opening) S-, M-, L-, D-ribbed, block frame

| LF of the opening | Ordering size = RAM | Lever height* from OFF | Door section height B |
|-------------------|---------------------|------------------------|-----------------------|
| 875 × 2000 | 855 × 1990 | 1050 | 500 |
| 875 × 2125 | 855 × 2115 | 1050 | 531 |
| 1000 × 2000 | 980 × 1990 | 1050 | 500 |
| 1000 × 2125 | 980 × 2115 | 1050 | 531 |

Profile type 1 (only opening inwards, internal fitting) S-, M-, L-ribbed, S-panelled, corner frame

| Ordering size = BRM | Lever height* from OFF | Door section height B |
|---------------------|------------------------|-----------------------|
| 875 × 2000 | 955 | 500 |
| 875 × 2125 | 1010 | 531 |
| 1000 × 2000 | 955 | 500 |
| 1000 × 2125 | 1010 | 531 |

Profile type 2 (internal or external fitting) S-, M-, L-, D-ribbed, corner frame

| Ordering size = BRM | Lever height* from OFF | Door section height B |
|---------------------|------------------------|-----------------------|
| 875 × 2000 | 1050 | 500 |
| 875 × 2125 | 1050 | 531 |
| 1000 × 2000 | 1050 | 500 |
| 1000 × 2125 | 1050 | 531 |

Explanations

- P1** Profile type 1 (narrow leaf frame)
P2 Profile type 2 (wide leaf frame)
LDB Clear passage width
LDH Clear passage height
RAM Overall frame dimension
LF Structural opening
BRM Nominal size
BRB Nominal size width
BRH Nominal size height
OFF Finished floor level

Special sizes

Single-leaf side doors:
On request

Double-leaf side doors:
1330 – 2500 × 1960 – 2558 mm

* You can find the lever heights for special sizes in the fitting data.

Experience Hörmann quality in new construction and modernisation

Hörmann products have impressive durability and high functionality. You can easily plan for new construction as well as modernisation. The carefully coordinated solutions make your home more beautiful, more secure and more comfortable.

GARAGE DOORS. GATE AND DOOR OPERATORS. ENTRANCE DOORS. RESIDENTIAL INTERNAL DOORS. STEEL DOORS. FRAMES. STORAGE SPACE SYSTEMS



Some of the products shown are equipped with special equipment and do not always correspond to the standard versions. The surface finishes and colours shown are subject to the limitations of the printing process and cannot be regarded as binding. All rights reserved. No part may be reproduced without our prior permission. Subject to changes.